

MAK SERIES



IP67 Waterproof Micro switch

特点 FEATURE

- 防水(IP67)设计 · Designed For Waterproof IP67
- 体型小巧、紧凑 · Small Compact Size
- 拥有开关安规认证 · Switch Safety Approvals
- 寿命长、可靠性高 · Long Life and High Reliability
- 配备各种形状的压杆 · Offer Variety Levers
- 接线端子种类齐全 · Complete Variety of Wiring Terminal

应用 APPLICATION

- 汽车 · Car
- 空调 · Air-Conditioner
- 通讯 · Communication
- 家用电器 · Home Appliance
- 电机控制器 · Motor Control
- 共享设备 · Sharing Device
- 玩具 · Toys
- 充电桩 · Charging Station

外形尺寸图 OUTLINE DRAWING

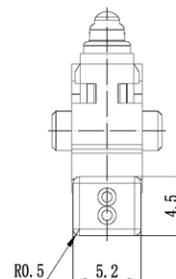
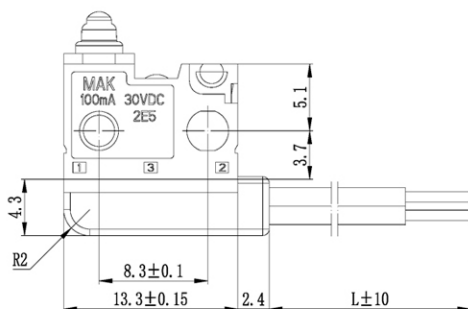
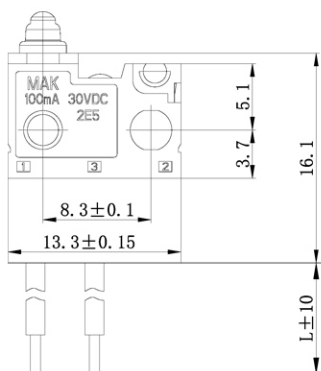
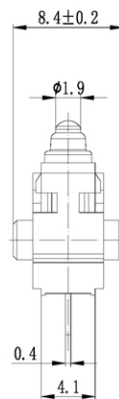
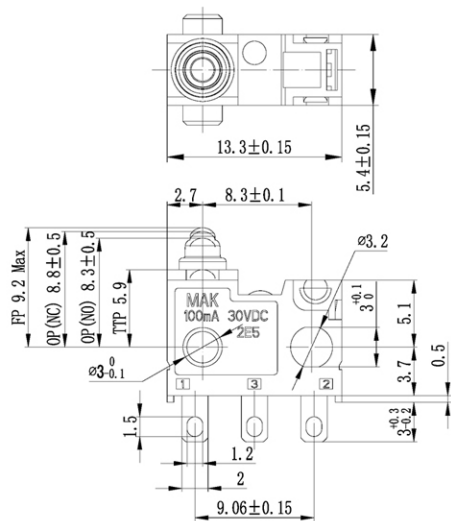

* 线材标准可以根据客户要求定制，出线方向可选侧出线或下出线。

* Wire standards can be customized according to customer requirements, The wire outlet direction can be side or lower.

特性参数 PARAMETERS

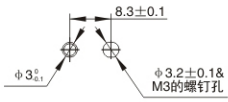
额定负载/Rated Load	100mA 30VDC
初始接触电阻/Initial Contact Resistance	1Ω Max (不含线束) Without wire
环境温度/Working Temperature	40T85
寿命/Service Life	电气/Electrical 200,000 Cycles
安装尺寸/Hole For Mounting	

订货型号指引 ORDERING INSTRUCTION

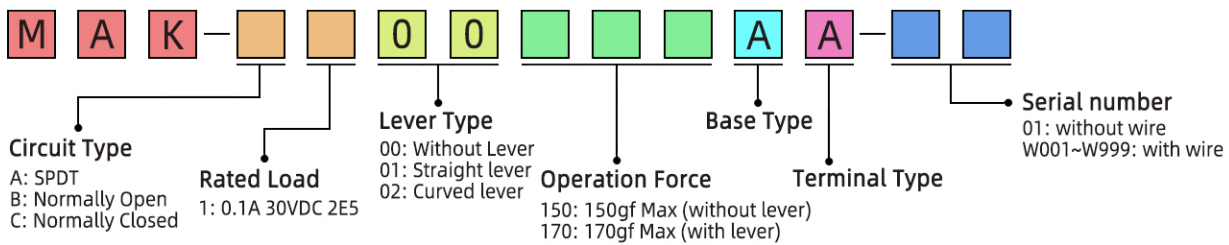

● 电路形式 Circuit type

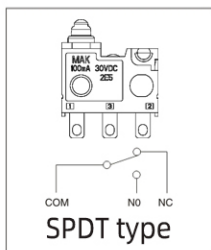

A

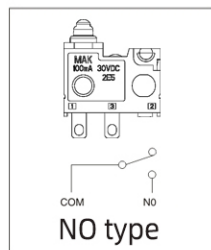

B

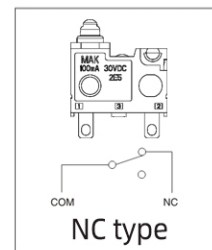

C

● 手柄类型 Lever type

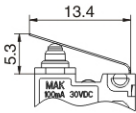
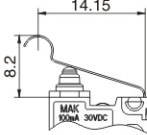
00		01		02		...	customization
----	---	----	---	----	--	-----	---------------

● 外壳类型 Base type

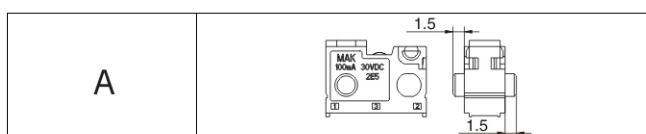

● 端子类型 Terminal type

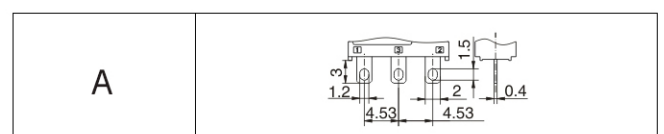

※ For more lever and terminal types, please contact us, We accept paid customization.

开关参数规格 SWITCH SPECIFICATION

● 一般特性 General

适用范围 Application Area:

该规格书指微动开关MAJ系列的一般使用范围

This specification refers to the general use of micro switch MAK series

使用温度范围 Operation Temperature rating : 参见产品图纸 See the outline drawing

相对湿度 Operation Relative Humidity : ≤85%at,+40°C

实验条件 Test conditions:

环境湿度 Ambient Temperature : 5~35°C

相对湿度 Relative Humidity: 45~85%

大气压力 Air Pressure: 86~106Kpa(860~1060mbar)

● 外观结构及尺寸 Appearance, Configuration and Dimensions

外观: 产品外观良好, 无氧化、裂纹和镀层缺陷

Appearance: Product appearance and no rust, crack and coating defects

结构尺寸 Structur and Dimension: 参见产品图纸 See the outline drawing

标识 Sign: 参见产品图纸 See the outline drawing

通过的安规认证 Safety Certification: RoHS,REACH

产品防护等级 Degree of protection: IP67(Except terminal)

● 电气性能 Electrical characteristic

No.	Item 项目	Criteria 标准	Test Method 实验方法
1	Contact Resistance 接触电阻	1 Ω max	Measured by a voltage drop method at 1A Max, 5VDC. Any equipment with error not more than 5% can be used. Resistance after test is the average of 5 successive measurements. 以 1A, 5V 直流电, 采用电压降法测量。也可用误差不超过 5% 的仪表进行测量, 实验后的电阻取 5 次测量的平均值。
2	Insulation Resistance 绝缘电阻	100M Ω min	100VDC voltage is applied between each pair of terminals and between the terminal and the metal frame for 60±5S. 在相互绝缘的所有端子之间及各接线端子与外露的非载流金属零件之间加载 100V 直流电, 持续时间 60±5S。
3	Dielectric Voltage 抗电强度	No dielectric breakdown shall occur. 无击穿现象发生。	600VAC(50~60Hz,leakage current 5mA) is applied between non-connected terminals; 1500VAC(50~60Hz,leakage current 5mA) is applied between terminals and out casing,or between terminals and non-loaded metal parts,last for 5s. 在相互绝缘的所有端子之间加载 600VAC(50-60Hz, 漏电流 5mA), 各接线端子与外壳或非载流金属件之间加载 1500VAC(50-60Hz, 漏电流 5mA), 持续时间 5s。

● 机械性能 Mechanical characteristic

No.	Item 项目	Criteria 标准	Test Method 实验方法
1	Terminal Strength 接线端强度	Shall be free from terminal looseness, damage and insulator breakage. The electrical performance requirements specified in section 3 shall be satisfied. 端子无松动, 损坏及绝缘层的破裂。 电气性能应符合第 3 条的要求。	A static load of 6N shall be applied to the tip of terminal in a desired direction for 60 ± 1s. The test shall be done once per terminal. 以 6N 作用力沿轴向逐渐施加于接线端末端, 作用力方向为离开开关向外指向, 每个接线端子测量一次。

● 机械性能 Mechanical characteristic

No.	Item 项目	Criteria 标准	Test Method 实验方法
2	Solder Ability & Resistance to Flux 可焊性与抗焊剂能力	<p>More than 80% of immersed part shall be covered with solder.</p> <p>Flux shall not be risen up to contact.</p> <p>The switch shall be free from abnormalities in operation.</p> <p>超过 80% 的浸锡面积被焊料所覆盖。</p> <p>焊剂不得上升进入开关内部，影响接触转换。</p> <p>试件在操作过程中不应发生变形。</p>	<p>Switch shall be checked after following test:</p> <p>(1) Solder: H63A (JIS Z3282)</p> <p>(2) Flux: Rosin Flux (JIS K 5902) having a nominal composition of 25% solids by mass of water white rosin in methyl alcohol (JIS K 1501) solution.</p> <p>(3) Soldering Temperature: $235 \pm 5^\circ \text{C}$ Immersing Time: $3 \pm 0.5\text{s}$ Flux immersing time shall be 5 ~10s in normal room temperature.</p> <p>(4) Immersion Depth: Immersion depth shall be at copper plating portion of PCB after mounting. (Thickness of PCB=1.6mm)</p> <p>试件在下述参数条件下进行试验:</p> <p>(1) 焊料: H63A (JIS Z 3282)</p> <p>(2) 焊剂: 焊剂 (JIS K 5902), 质量百分比为 25% 松香, 75% 甲醇的无色透明溶液。</p> <p>(3) 焊接温度: $235 \pm 5^\circ \text{C}$ 浸渍时间: $3 \pm 0.5\text{s}$ 焊剂浸渍时间: 5-10s</p> <p>(4) 浸渍深度: 接线端应浸到离开关根部 1.6mm 处。</p>
3	Solder Heat Resistance 耐焊接热	<p>No abnormalities shall be observed in appearance and operation.</p> <p>The electrical performance requirements specified in item 3 shall be satisfied.</p> <p>无外观及功能损坏。</p> <p>电气性能应符合第 3 条的要求。</p>	<p>Switch shall be measured after following test:</p> <p>(1) Solder: H63A (JIS Z3282)</p> <p>(2) Flux: Rosin Flux (JIS K 5902) having a nominal composition of 25% solids by mass of water white rosin in methyl alcohol (JIS K 1501) solution.</p> <p>(3) Soldering Temperature & Immersing Time Dip Soldering $260 \pm 5^\circ \text{C}$ $5 \pm 1\text{s}$ Manual Soldering $350 \pm 5^\circ \text{C}$ $2 \sim 3\text{s}$</p> <p>(4) Immersion Depth: (For Dip Soldering) Immersion depth shall be at copper plating portion of PCB after mounting. (Thickness of PCB=1.6mm)</p> <p>试件在下述参数条件下进行试验:</p> <p>(1) 焊料: H63A (JIS Z 3282)</p> <p>(2) 焊剂: 焊剂 (JIS K 5902), 质量百分比为 25% 松香, 75% 甲醇的无色透明溶液。</p> <p>(3) 焊接温度及浸渍时间: 自动焊接 $260 \pm 5^\circ \text{C}$ $5 \pm 1\text{s}$ 手工焊接 $350 \pm 5^\circ \text{C}$ $2 \sim 3\text{s}$</p> <p>(4) 浸渍深度: (对于手动焊接) 接线端应浸到离开关根部 1.6mm 处。</p>

● 寿命试验 Life test

No.	Item 项目	Criteria 标准	Test Method 实验方法
6.1	Mechanical Life 机械寿命	<p>After test, Contact resistance: 5Ω max Insulation resistance: $50\text{M} \Omega$ min</p> <p>The electrical performance requirements specified in item 4.3 shall be satisfied.</p>	<p>200,000 cycles of operation shall be performed continuously at a rate of 30 cycles per minute without load.</p> <p>在不带负荷的条件下, 速度为 20 次/分, 在寿命试验设备上连续转换 200,000 次。</p>
6.2	Electronics Life 电气寿命	<p>The switch shall be free from abnormalities in appearance construction.</p> <p>实验后: 接触电阻: 5Ω max. 绝缘电阻: $50\text{M} \Omega$ min. 电气性能应符合第 4.3 条的要求。 开关外观及结构应无损坏。</p>	<p>operation shall be performed continuously at a rate of 30 cycles per minute with load as follow</p> <p>在带以下负荷的条件下, 速度为 20 次/分, 在寿命试验设备上连续转换。</p> <p>100mA 30VDC 200,000 cycles</p>

● 耐候实验 Environmental test

No.	Item 项目	Criteria 标准	Test Method 实验方法
1	Cold Proof 低温	After test, Contact resistance: 5 Ω max Insulation resistance: 50M Ω min. The Electrical performance requirements specified in item 3 shall be satisfied. The switch shall be free from abnormalities in appearance & construction. 实验后: 接触电阻: 5 Ω max. 绝缘电阻: 50M Ω min. 电气性能应符合第 3 条的要求。 开关外观及结构应无损坏。	After testing at $-40 \pm 2^{\circ}\text{C}$ for 96 hours, the switch shall be allowed to stand under normal temperature and humidity conditions for 1 hour, and measurement shall be made within 1 hour after that. Water drops shall be eliminated. 试件在 $-40 \pm 2^{\circ}\text{C}$ 的温控箱内保持 96 小时, 然后在正常温度和湿度下恢复 1 小时, 并在此后 1 小时内对试品进行测量, 水滴应消失。
2	Hot Proof 高温		After testing at $85 \pm 2^{\circ}\text{C}$ for 96 hours, the switch shall be allowed to stand under normal temperature and humidity conditions for 1 hour, and measurement shall be made within 1 hour after that. 试件在 $85 \pm 2^{\circ}\text{C}$ 的温控箱内保持 96 小时, 然后在正常温度和湿度下恢复 1 小时, 并在此后 1 小时内对试品进行测量, 水滴应消失。
3	Moisture Resistance 恒定湿热		After testing at $40 \pm 2^{\circ}\text{C}$, 90~95% RH for 96 hours, the switch shall be allowed to stand under normal temperature and humidity conditions for 1 hour, and measurement shall be made within 1 hour after that. Water drops shall be eliminated. 试件在 $40 \pm 2^{\circ}\text{C}$, 90-95%RH 的温控箱内保持 96 小时, 然后在正常温度和湿度下恢复 1 小时, 并在此后 1 小时内对试品进行测量, 水滴应消失。
4	Temperature Cycling 温度转换		After 5 cycles of following conditions, the switch shall be allowed to stand under normal temperature and humidity conditions for 1 hour, and measurement shall be made within 1 hour after that. Water drops shall be eliminated. 试件按下述实验条件试验 5 次, 然后在正常温度和湿度下恢复 1 小时, 并在此后 1 小时内对试品进行测量, 水滴应消失。
5	Ingress Protection 防护等级	IP67	Prevent foreign objects and dust 防止外物及灰尘 In the depth of 1 meter of water, 30 minutes of immersion has no effect (the temperature difference with the switch is below 5°C) 在深达 1 米的水中防 30 分钟的浸泡无影响, (水和开关的温度差在 5°C 以下)

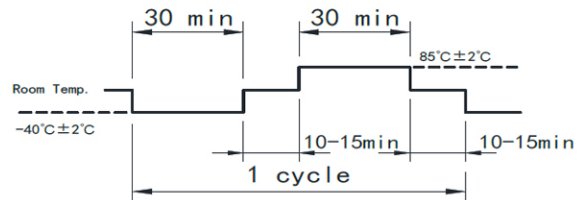

● 开关的储存 Storage of switches

- 请避开产生污染气体、有机气体的区域(如燃气、取暖器附近)以及灰尘、潮湿等环境。
Please avoid areas that produce polluted gases, organic gases (such as gas, near heaters), dusty, humid environments, etc.
- 保存温度湿度: 温度 $5 \sim 35^{\circ}\text{C}$, 湿度 $\leq 80\% \text{RH}$
Temperature & Humidity: Temp $5 \sim 35^{\circ}\text{C}$ and Hum 80% RH Max.
- 开关储存期为6个月, 超过6个月需重新检查。
The storage period is 6 months, re-inspected over 6 months.

● 开关的使用 Use of switches

小心不要让开关跌落地面和受猛烈冲击, 这样可能使开关的内部元件损坏, 因开关的设计是适用于微小操作力的。
Be careful not to drop the switch to the ground and subject it to violent shocks which may damage the internal components of the switch because the switch is designed for small operating forces.